

# Vibration Testing

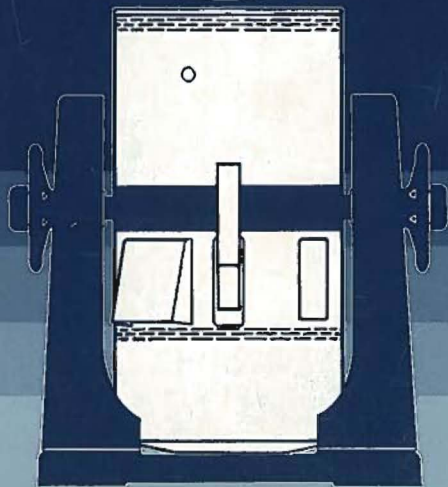

# Introduction

This booklet gives an introduction to the methods used in vibration testing and a description of the vibration exciters and control equipment used in environmental testing and in determination of dynamic properties of structures.

	See page
<b>Introduction</b>	1
<b>Why vibration testing?</b>	2
<b>How does an exciter work?</b>	3
<b>The power amplifier</b>	4
<b>The exciter control</b>	4
<b>Basic exciter instrumentation</b>	5
<b>Sine excitation</b>	5
<b>Random excitation</b>	6
<b>Environmental testing</b>	7
<b>Mounting of the test object</b>	7
<b>Fixtures</b>	8
<b>Static compensation</b>	9
<b>Vibration response investigation</b>	10
<b>Endurance conditioning</b>	11
<b>Swept sine testing</b>	11
<b>Conditioning at single frequencies</b>	12
<b>Random testing</b>	13
<b>Derivation of test data</b>	14
<b>Structural research</b>	15
<b>Mechanical impedance and mobility</b>	16
<b>Addition of impedances and mobilities</b>	17
<b>Complex elastic modulus</b>	18
<b>Mode studies</b>	19
<b>Resonance studies</b>	20
<b>Use of complex plots</b>	21
<b>Excitation methods</b>	22
<b>Multi-shaker systems</b>	23



## Why Vibration Testing?

Due to the demands of high speed operation and the use of light structures in modern machinery, static measurements of stress/strain properties are not sufficient. Dynamic measurements are necessary and vibration testing has therefore found widespread use.

In the environmental laboratory, vibration testing is performed as part of a company's quality assurance programme together with for example temperature and humidity tests to ensure product reliability. The test object is exposed to a certain vibration level according to a procedure specified by national and international standards.

To find the dynamic properties of a structure, the response to a vibrational force is of interest rather than the actual vibration level. This concept is found for instance in determination of the ability to transmit or damp vibrations or in the description of the vibrational modes of a structure at resonances.

In the calibration of vibration transducers a comparison is made between the transducer to be calibrated and a reference transducer at a prescribed vibration level.

To produce a defined vibration an electromagnetic vibration exciter (also called a shaker) is used. This converts an electric signal into a mechanical movement, controlled to maintain a certain vibration level or force.

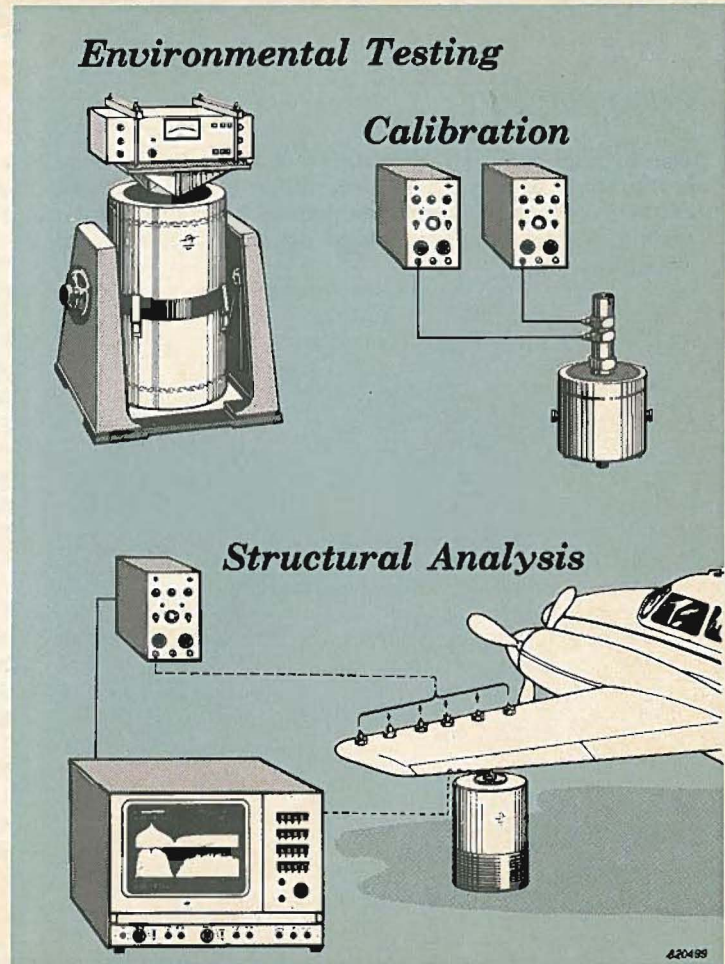

# How Does an Exciter Work?

In principle the electromagnetic vibration exciter operates like a loudspeaker, where the movement is produced by a current passing through a coil in a magnetic field. The force used to accelerate the moving element is proportional to the drive current and the magnetic flux. Therefore by controlling the current, the vibration level of the exciter can be controlled.

In small exciters the magnetic field is produced by a permanent magnet, whereas in the larger ones electromagnets are necessary. The maximum current and the load determines the acceleration level which can be obtained. At low frequencies, however, this acceleration level will decrease due to displacement limitations of the moving element. Resonances in the moving element will set the upper frequency limit.

The performance of an exciter is presented in a diagram, showing the maximum acceleration as a function of frequency. With double logarithmic scales the displacement limit will be represented by a straight line with a slope of 12 dB/octave. A velocity limit is often also found, especially with the larger exciters, and this is indicated by a line with a slope of 6 dB/octave.

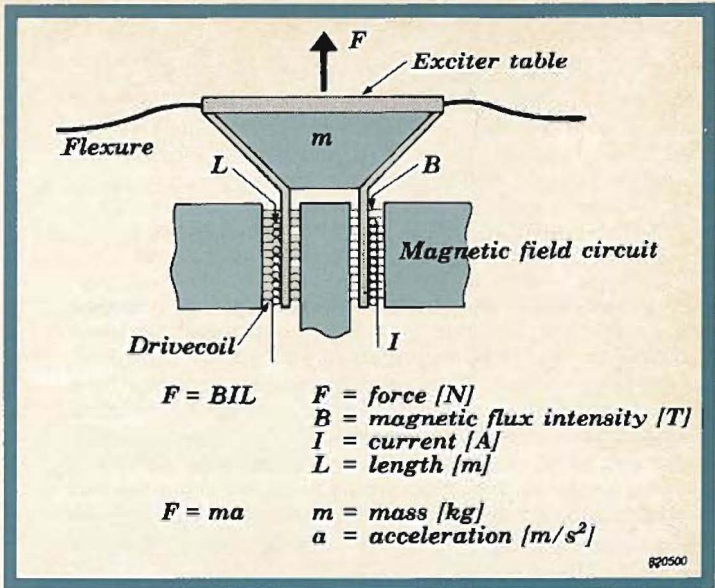

$$F = BIL$$

$F = \text{force [N]}$   
 $B = \text{magnetic flux intensity [T]}$   
 $I = \text{current [A]}$   
 $L = \text{length [m]}$

$$F = ma$$

$m = \text{mass [kg]}$   
 $a = \text{acceleration [m/s}^2\text{]}$

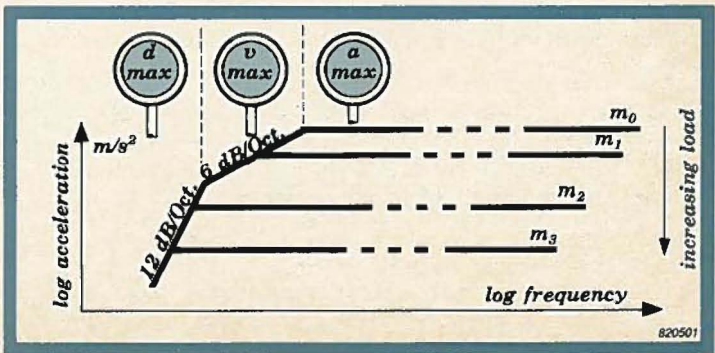



## The Power Amplifier

The frequency response for an exciter driven by a constant current will show three regions of different nature. The first two regions represent the spring-mass system of the moving element and its suspension with a resonance of typically 20 Hz. In the third region, typically above 5 kHz for big exciters, axial resonances in the moving element will occur, setting the upper operational frequency of the exciter.

A response curve for an exciter with a constant voltage input will show the same regions of control, but the lower resonance is considerably damped, giving an easier control of the level. The voltage control, obtained by a low impedance amplifier is normally preferred. In some cases, however, a current control will be advantageous, primarily when the exciter is used as a force generator or where non-feedback control is required using the mid frequency range of the exciter. This demands a high impedance output and therefore amplifiers will often have selectable impedance outputs.

## The Exciter Control

The use of a vibration exciter assumes a constant vibration level at the table. The frequency response curve is not flat, it contains resonances, and other resonances will be introduced when a test object is mounted on the exciter. When used throughout a frequency range the gain of the amplifier must consequently vary with frequency. This gain is set by a controller, receiving feedback information from the test object. The main elements of an exciter control must therefore be a frequency generator, a vibration meter and a level controlling circuit.

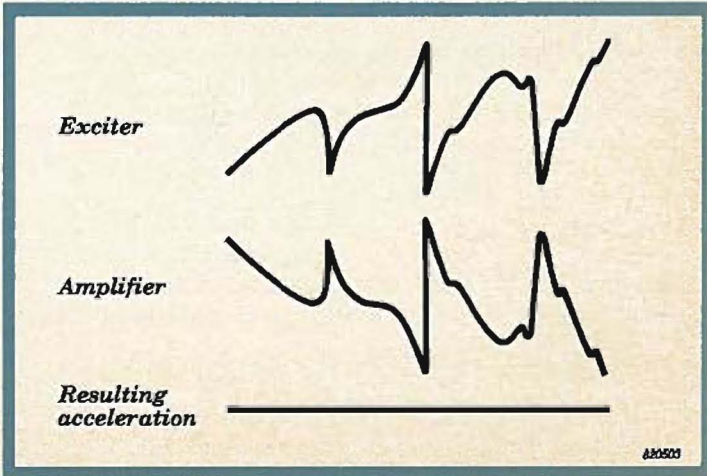
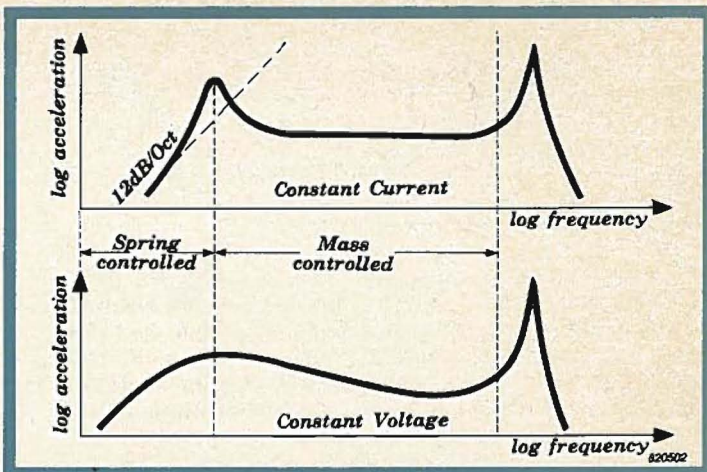



## Basic Exciter Instrumentation

A basic set-up consists of an exciter, a power amplifier, an exciter control, an accelerometer or force transducer and a conditioning amplifier.

The exciter is selected primarily according to the force or acceleration required, but other parameters may be important such as its ability to take up side loads, the transverse vibration and the distortion of the waveform.

The exciter is isolated from its base by springs, in most cases giving sufficient protection from environmental vibration when bolted directly on the floor. However, to reduce the vibration transmitted to the building by exciters used for high level applications, the exciter must be mounted on resilient material or a seismic block.

## Sine Excitation

Sine signals, swept or at a single frequency, are by far the most commonly used excitation inputs: the control is relatively simple, a large amount of reference material exists, and the response signals are easy to measure. When the signals are swept, a feedback control, known as a compressor is applied. The demand to the compressor is that it should be fast enough to react to low damped resonances even at high sweep rates. A dynamic range of at least 80 dB and compressor rates up to 1000 dB/sec are normally found.

Sine signals are described by their frequency and amplitude. In vibration testing the amplitude is normally in terms of peak values (displacement as peak-peak) with frequencies ranging between 2 and 10,000 Hz.

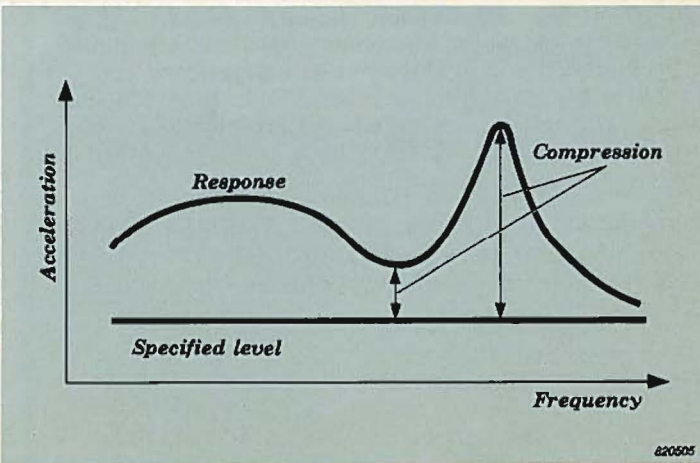
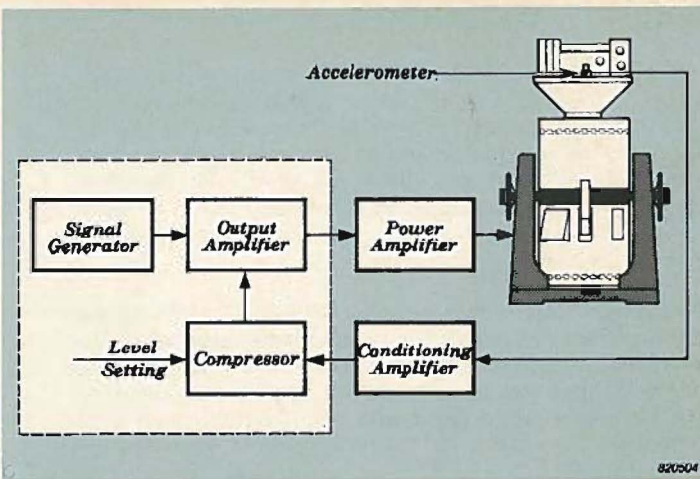



# Random Excitation

A random signal used in vibration testing has a continuous spectrum, with amplitudes varying according to a Gaussian distribution. Within the specified frequency range any amplitudes should be present, but in practice the generators and amplifiers will give limitations. In vibration testing it is generally demanded that a random signal should contain peak-values of three times the RMS value.

The force produced by an exciter is mainly limited by the heating effect of the current, i.e. the RMS value, whereas the power amplifier rating is influenced by the peak values. To give the same force the amplifier must therefore be larger when used with random than with sine excitation.

The random spectrum is described by its power spectral density or acceleration spectral density, ASD  $[(m/s^2)^2/Hz]$ . To shape and control this, the vibration must be analyzed by a narrow band analyzer and compressor loops applied to each bandwidth. Digital techniques based on Fourier transforms are normally used and the control is achieved using a computer, a process called equalization.

The random capacity of an exciter is specified as the maximum acceleration spectral density at different loads of a spectrum, shaped according to the International Standard, ISO 5344.

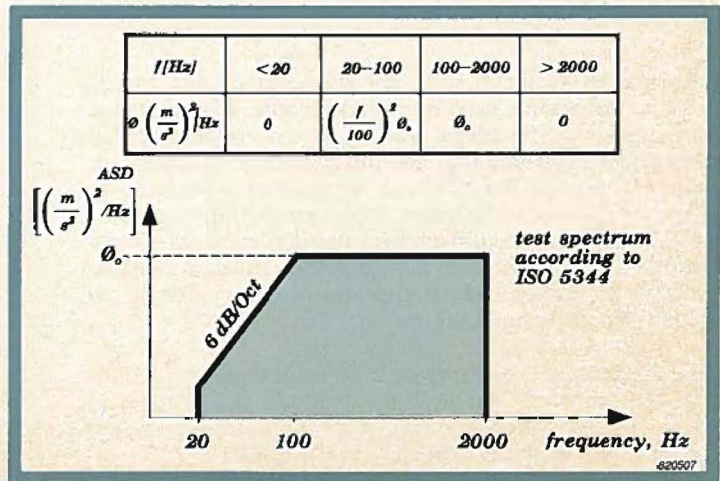
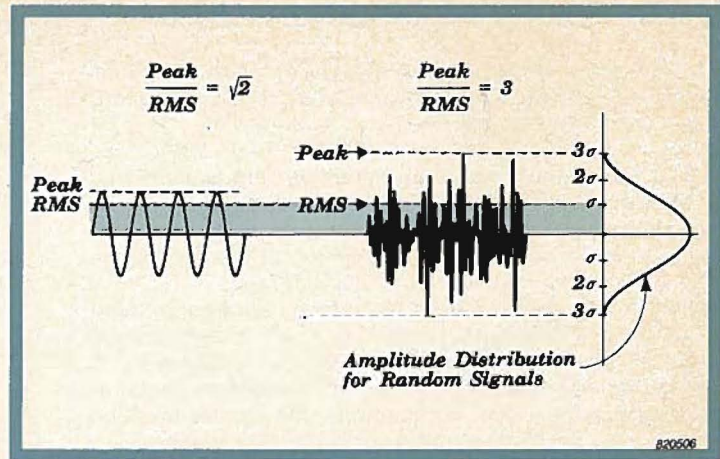

# Environmental Testing

An environmental test is performed to determine the ability of equipment to withstand specified severities of vibration, shock, temperature, humidity, etc. The requirements may be set by the user or the supplier with reference to some national or military standard. These standards describe the test procedures, but do not state the individual test levels.

The fundamental standards are IEC 68, tests Fc and Fd, which in several countries have been accepted as national standards. The contents of all standards largely fall into 3 groups: the mounting of the test object, the endurance conditioning and the vibration response investigation.

## Mounting of the Test Object

As the test is performed to simulate the environmental influence, the object must be mounted on the exciter table by its normal means of attachment. In most cases this requires a special fixture, which allows the specimen to be vibrated along the specified axes.

The method of mounting must be described in the test, and so must the point on the specimen to which the control accelerometer is attached. Also, it must be specified whether the object should be operating during the test.



### **TEST STANDARDS**

- *Mounting the specimen*
- *Vibration response investigation*
- *Endurance conditioning*



## Fixtures

In cases where the test object cannot be mounted directly on the exciter table a fixture, sometimes of a rather complex nature, is required for fastening the object. The fixture must be stiff enough to transmit the generated force or motion uniformly to the test object, thus not introducing any resonances. It is important to check the design by measuring the vibration levels on the surface of the fixtures by means of accelerometers. All resonances must lie outside the test frequency range.

The natural frequency of a construction will be almost the same whether the material is steel or aluminum and as the total weight of test object and fixture is a restricting factor in the application of an exciter, aluminium will normally be the best choice.

To obtain a high resonance frequency, it will always be necessary to over-dimension the structure, so no considerations normally have to be taken concerning the mechanical strength.

For minimizing the weight of the fixture it can be constructed of relatively thin plates, supported by braces. The plates are of simple geometric shapes with responses easy to calculate. Much care should be taken in assembling: bolts can introduce spring/mass effects, welding can introduce internal stresses.

If resonances cannot be avoided the damping can be increased by laminating with a damping material such as rubber or by filling cavities with foamed plastic.

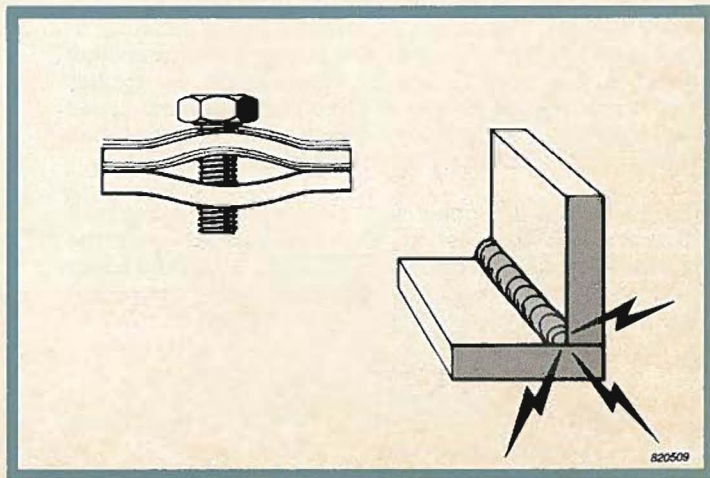
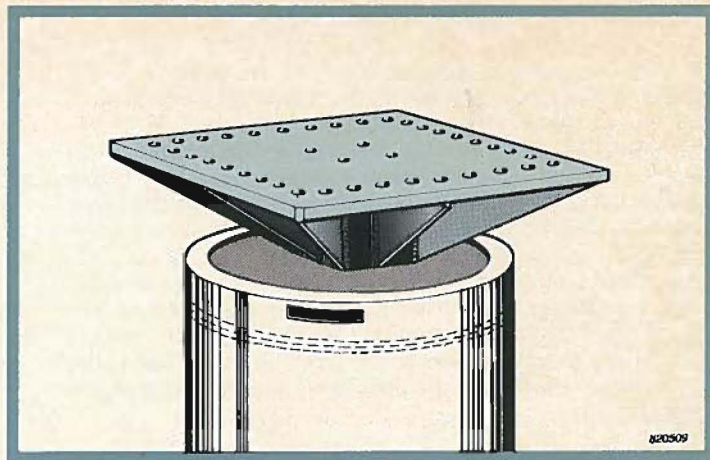

# Static Compensation

Heavy test objects will cause a static deflection of the exciter table dependent on the stiffness of the flexures. This decreases the available displacement for the dynamic performance and it may be necessary to compensate for this static loading when operating with large dynamic displacements, i.e. especially in the low frequency range. A simple means of compensating is to apply a DC current to the moving coil, but as this current contributes to the heating of the exciter and power amplifier, the dynamic performance will be reduced. The compensation is therefore more often made by external mechanical supports, e.g. springs suspended from the ceiling, horizontal slip tables supported by flexures, or sliding on an oil film.

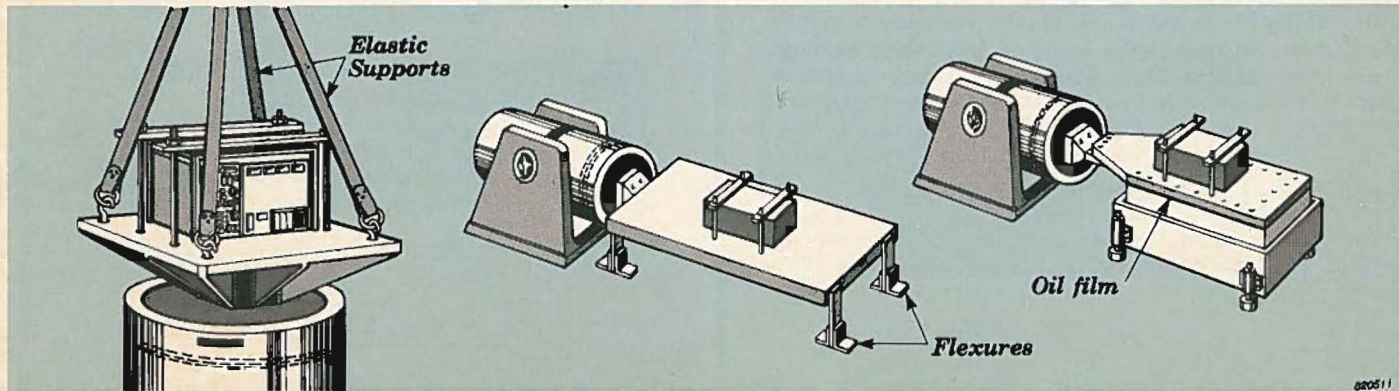
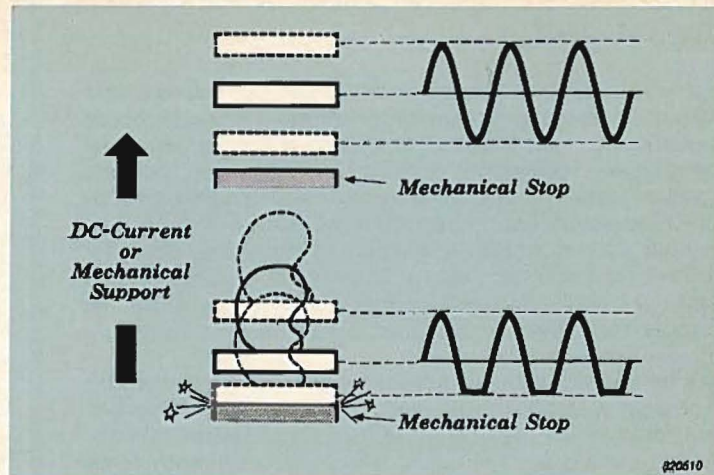



## Vibration Response Investigation

The first step after mounting the test object is to make a vibration response investigation with the purpose of checking its function and to examine the influence of resonances throughout the frequency range. For all types of tests the resonances are found by a sine sweep. The resonance frequencies are measured and the behaviour of the structure studied in detail by manually controlling the frequency. At the end of the test procedure a similar investigation is carried out for comparison.

The behaviour of the structure is most easily studied by means of a stroboscopic lamp, triggered by the exciter control to follow the excitation frequency. Better, however, is to use a trigger signal which differs slightly from the excitation frequency, giving a slow-motion like image. This slow-motion frequency, normally 3 - 5 Hz, can be set on the stroboscope to follow the excitation. A further study of the behaviour can be made by manually delaying the trigger signal to move the image through one or more cycles or by using dual flashes to give a picture of the extreme positions of the resonating part.

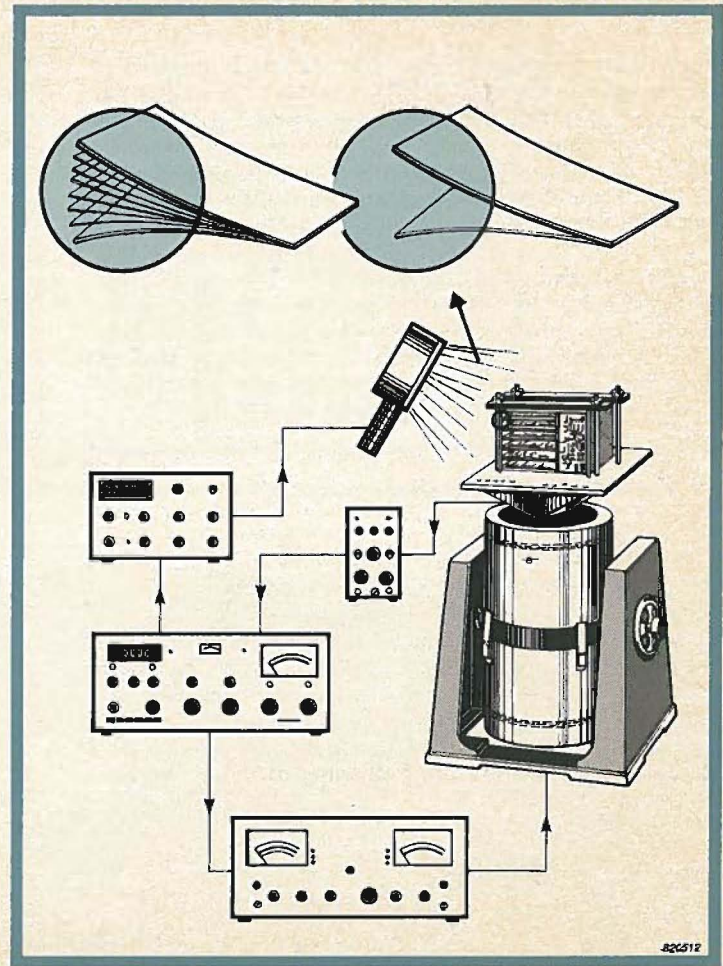

# Endurance Conditioning

During the endurance conditioning the specimen is subjected to a vibration, which in severity, i.e. frequency range, level and time, should ensure that it can survive in the real environment. Dependent on these, the conditioning is performed by sine sweeping, sine testing at the resonance frequencies or at other pre-determined frequencies, or by random vibration.

## Swept Sine Testing

In the swept sine test the signal to the exciter is continuously swept back and forth over the appropriate frequency range. The main control parameter is the acceleration level, but below a certain frequency (the cross-over point) a constant displacement is chosen. In the IEC-test the cross-over frequency is 60 Hz and the levels of displacement and acceleration are chosen to change continuously from one parameter to another. Other standards, e.g. the military standards, may demand further changes of level or of vibration parameter.

Therefore, the exciter control used for environmental sine testing, has at least two measuring channels with integrators to calculate the displacement and velocity levels from the acceleration level measured by the control accelerometer. There must also be a switching facility, to change the measuring channel at the cross-over frequency.

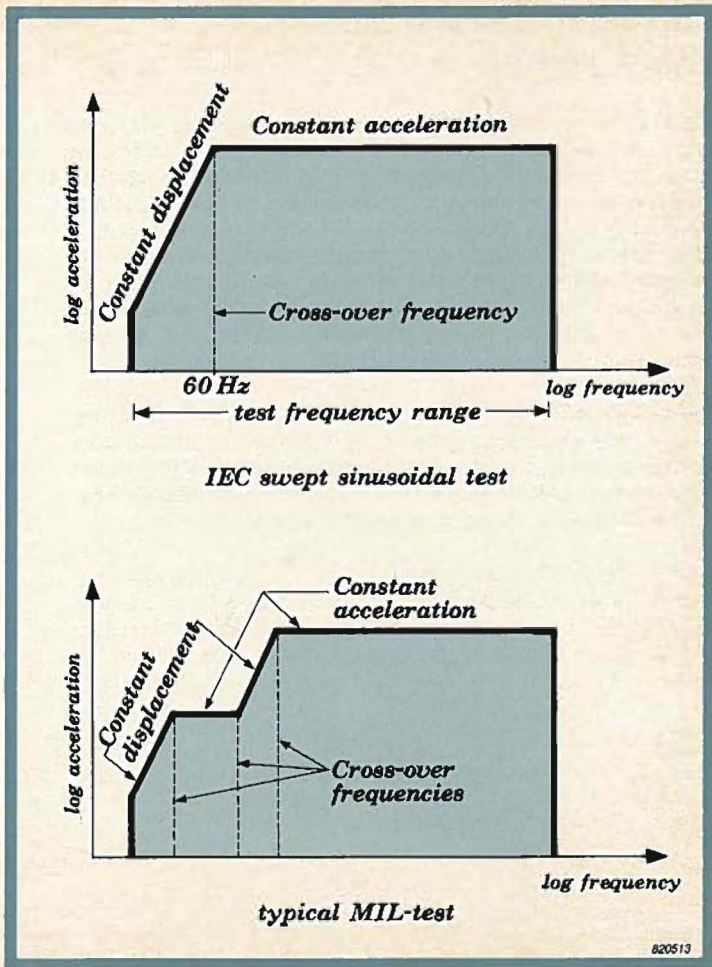



## Conditioning at Single Frequencies

If the expected environment is dominated by one or a few discrete frequencies, the endurance conditioning is most realistically performed only at these frequencies, often as fatigue testing to break-down of the material.

Specimens showing some clearly evident resonances can successfully be tested at these resonances. Due to changes in the structure during the test, the resonance frequency is likely to move and in order to change the excitation frequency automatically, a resonance dwell unit is used. It works on the fact that at resonance the phase angle between the excitation and the response signals will change drastically. It is therefore possible to consider the phase angle as characteristic of the resonance, and it is measured and used as a reference in a servo loop controlling the excitation frequency.

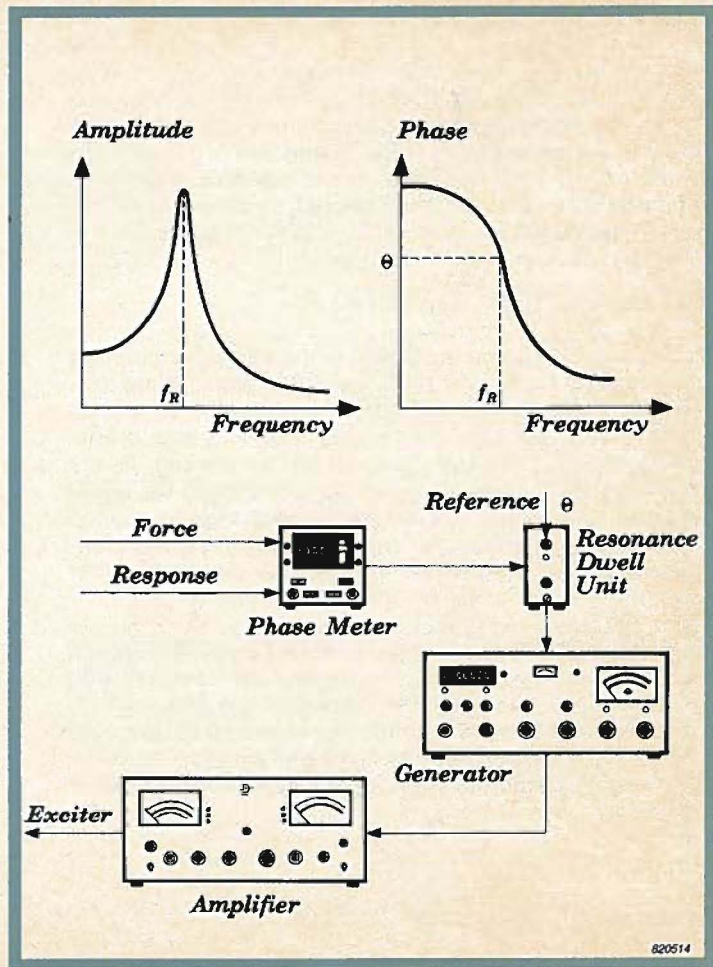

# Random Testing

Although sine testing is by far the most widely used vibration test due to the relatively low price and simple instrumentation, a random excitation will better simulate the real environment. In sine testing only a single resonance will be excited at a time and any mutual influence of resonances will not be detected. Another advantage of the random testing is that the time of endurance is shorter because it acts on all resonances at the same time.

A random test is specified by its acceleration spectral density spectrum (ASD), which is shaped by an equalizer and controlled by the total acceleration RMS level of the spectrum.

The high price and complexity is an obstacle for the wider use of random test systems and compromises using excitation without automatic equalization, e.g. by recording a computed spectrum on a tape, are met when the demands to the reproducibility are small.

One approach combining a simple feed-back control with many of the advantages of the random spectrum is the swept narrow band technique. In a standard sine control the single frequency signal is substituted by a random band and the overall vibration level is controlled by the compressor. With a fairly narrow bandwidth the control is satisfactory even for low damped resonances.

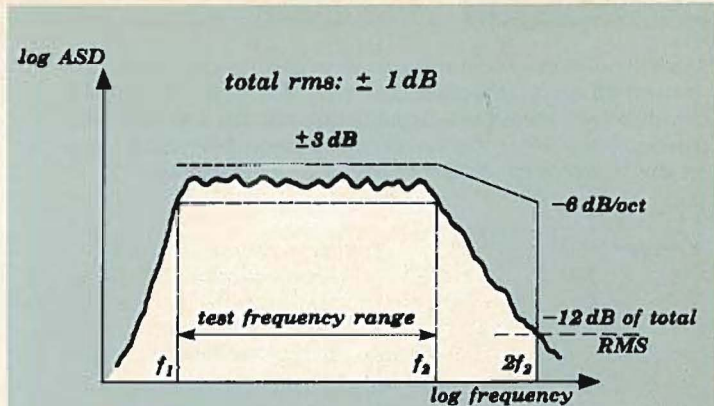

*IEC random test, reproducibility high*

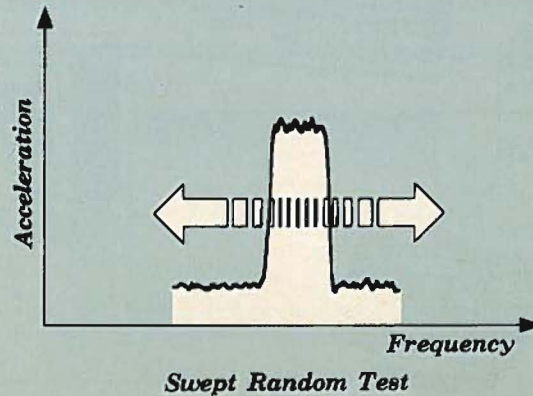



## Derivation of Test Data

The purpose of test standards is to ensure that tests are performed in a reproducible way. A range of recommended test levels are stated, but not for specific objects and therefore the severities chosen must be based on the experience of the manufacturer or buyer.

In any case the basis of a test specification is a knowledge of the expected environment. This can be obtained from long-time measurements of the vibration levels on site, normally using portable equipment including an instrumentation tape recorder. The data is analyzed and an "envelope" of all measured data gives useful information to the demands of the test.

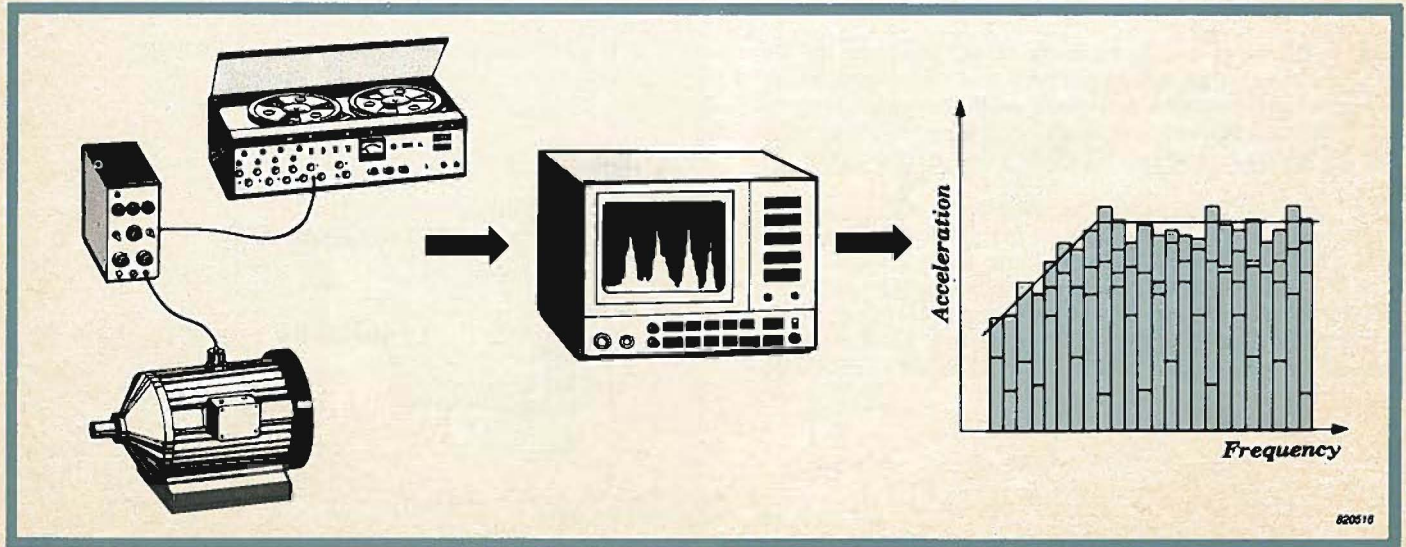

# Structural Research

Characteristic to the study of the influence of vibrations on structures is that it involves measurement of the response to an applied force. The frequency response is generally often called the mechanical impedance, but strictly speaking this is confined to be the complex ratio of force to velocity. Other ratios involving force and the vibration parameters, acceleration, velocity and displacement are shown in the table.

Although the spectra of any of the parameters will give the same information, the velocity will generally be used to describe the vibration as experience shows it presents the most "flat" curve, thus giving a larger dynamic range. Also, the velocity is the parameter most closely related to the strain levels in the structure. Therefore the mechanical impedance and the mobility are more commonly used than the other parameters.

One example where the mobility has to be considered is when vibration measurements on machines are performed in order to obtain information on the stresses appearing inside the machine. The forces cannot be measured directly but only through their vibrational response on bearings etc. This response is dependent on the mobility (or impedance) of the structures and changes in the mobility spectrum, from for example repairs, will therefore change the measured response.

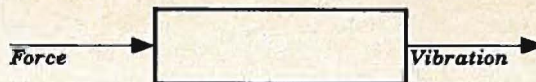

<i>Dynamic mass</i>	$\frac{F}{a}$	<i>Acceleration</i>	$\frac{a}{F}$
<i>Mechanical impedance</i>	$\frac{F}{v}$	<i>Mobility</i>	$\frac{v}{F}$
<i>Stiffness</i>	$\frac{F}{d}$	<i>Compliance</i>	$\frac{d}{F}$

820517

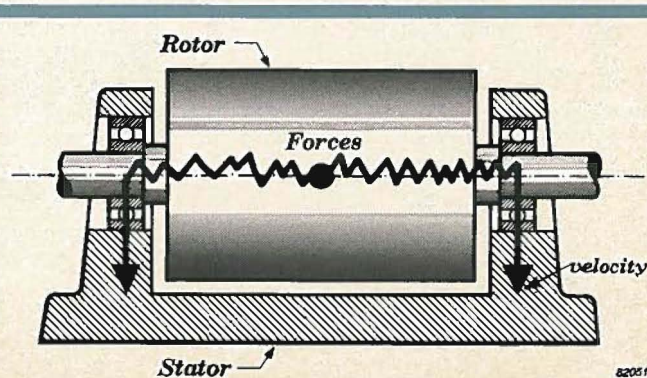

820518



# Mechanical Impedance and Mobility

The mobility spectrum can be found from a sine sweep with a constant force applied to the structure by a vibration exciter. The force is transferred via a push rod and maintained constant by instrumentation similar to that used in environmental testing except that the level is measured by a force transducer. The response is measured with an accelerometer and plotted on a recorder, synchronised to the generator frequency.

Similarly the impedance spectrum can be found by maintaining a constant velocity and measuring the force.

In most applications only the behaviour at resonances is of interest and as the force here needs only compensate the internal damping, relatively small exciters can be used even for large structures. On light structures the mass of the accelerometer should be low to minimize the influence of the additional mass on the dynamic behaviour of the structure.

Often a plot of impedance or mobility as a function of frequency will give sufficient information, whilst in other cases a further analysis of the response will be necessary to give a complete picture of the dynamic properties.

In any case, to understand the curves it may be useful to consider the structure as consisting of a number of masses, springs and dampers, for which the mechanical impedances are easy to calculate.

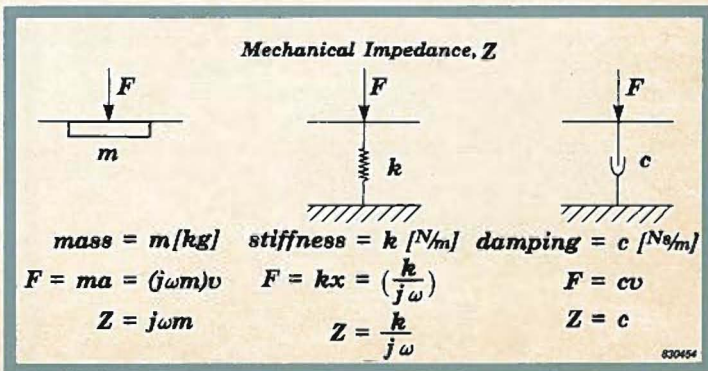
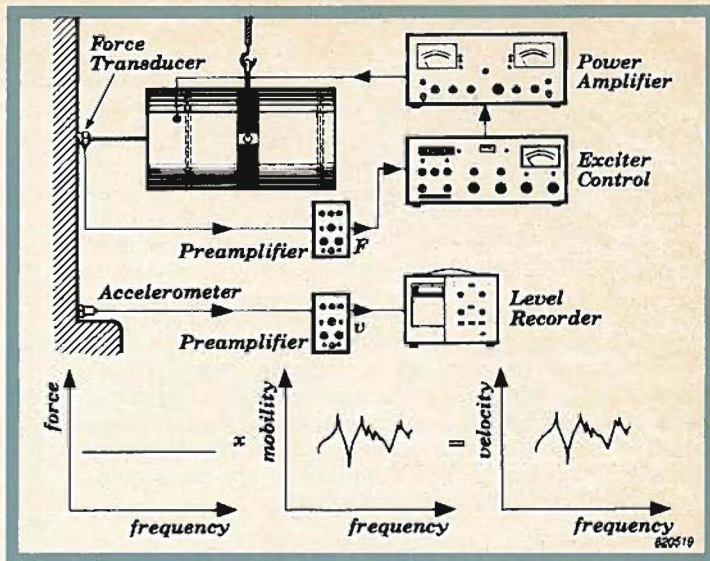

# Addition of Impedances and Mobilities

The impedance of the single elements of a structure will, on double logarithmic curves, appear as straight lines, and from the single element curves the impedance (or mobility) curves for complex systems can be found. The figure to the right shows a simple spring-mass system without damping with the force acting in parallel. The total impedance of the parallel system is the vector sum of the two single impedances, and the impedance curve can be constructed as shown. In a series system however the mobilities must be added to give the total mobility. The figure below illustrates a combined parallel and series system and its mechanical impedance as a function of frequency. The impedance and mobility plots not only give information on the resonance frequencies, but the behaviour (spring-like, mass-like) also gives the designer valuable information concerning possible modifications.

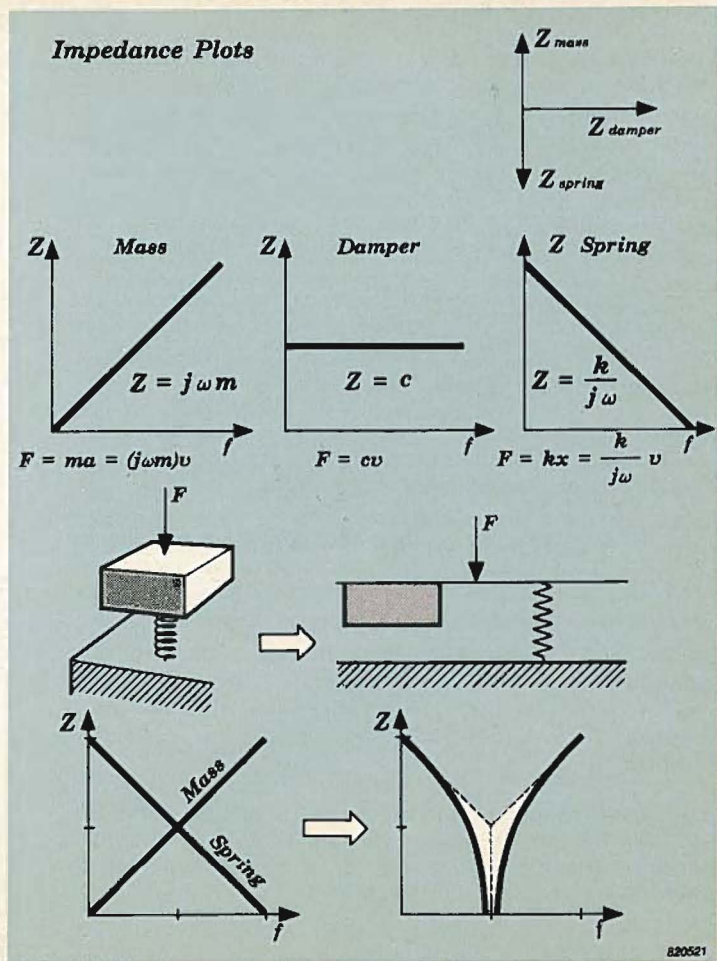
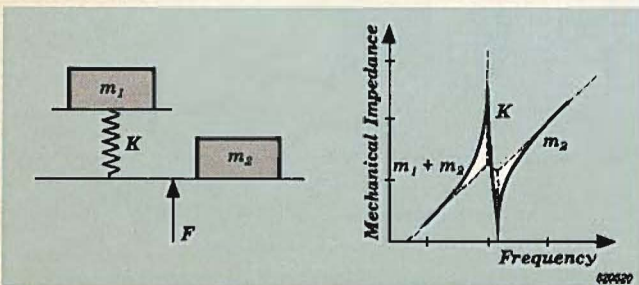



# Complex Elastic Modulus

The Modulus of Elasticity,  $E$ , of a structure is defined as the ratio of the stress,  $\sigma$ , to strain,  $\epsilon$ . A static determination of the modulus does not take into account the internal damping, which results in the stress and strain not being in phase under vibration conditions. Where the internal damping is to be considered e.g in plastics, asphalt, concrete and other viscoelastic materials, the Complex Modulus of Elasticity must be measured.

The Modulus is the vectorial sum of the Elastic and the Damping Modulus. It is related to the Loss Factor,  $\eta$ , of the material,  $\eta$  being the tangent of the phase angle,  $\phi$ , between the Elastic and the Complex Modulus.

A dynamic test will therefore consist of an excitation with a constant force and measurement of corresponding values of displacement and phase.

The figure shows one method with simplified formula for a beam excited by a sinusoidal force at its mid-point. The formula includes correction factors for compensating the effects of mounting the probe, transducers etc.

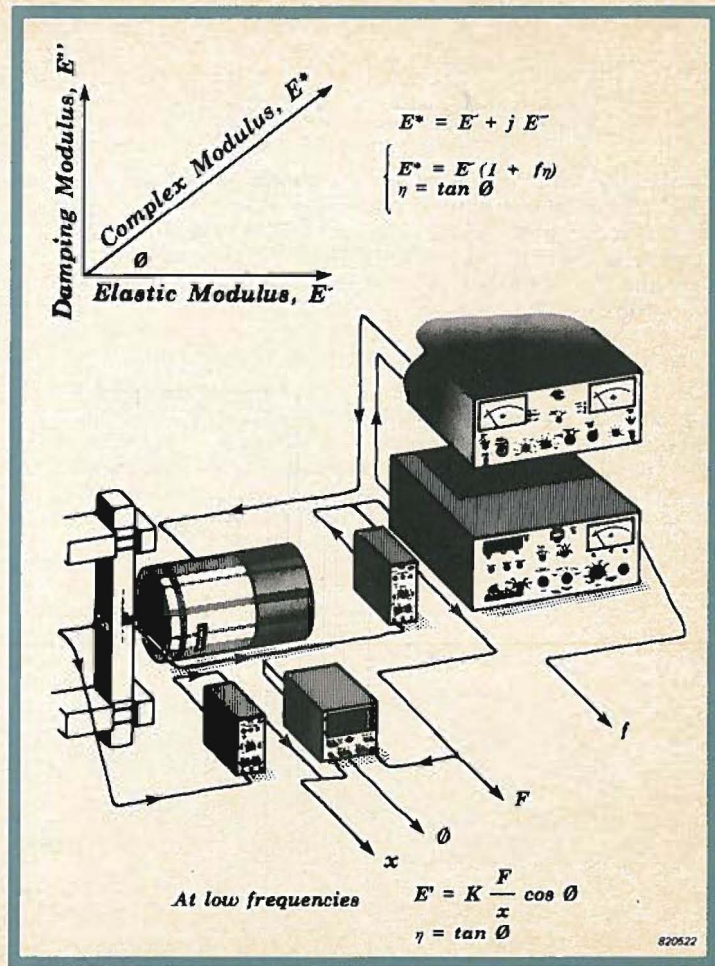

# Mode Studies

The measurement of mobility or mechanical impedance gives the frequency response function between the point of excitation and another point on the structure.

However, frequency response functions exist between all points of the structure, and if the structure is to be described in this way, the result will be a very large number of functions. Data reduction is therefore necessary and the technique used is to describe the modes of the structure.

At particular frequencies, the natural frequencies, the structure will vibrate in a shape called the mode shape. These frequencies are recognized as resonances of the structure and are indicated as minima on the mechanical impedances curves and maxima on the mobility curves.

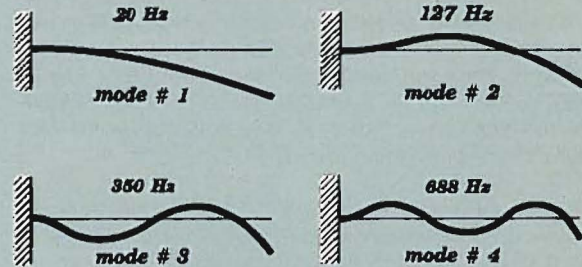

**Resonance Frequency**  
**Damping**  
**Mode Shape**

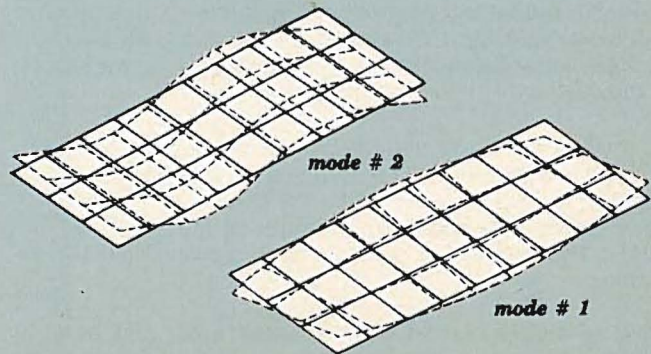



# Resonance Studies

Characteristic to the behaviour of a structure at resonance is the increase of vibration amplitude and the change of phase between force and response. Higher damping gives a lower and broader peak and a phase change over a broader frequency range. The damping is described by the quality factor  $Q$ , related to the bandwidth of the response curve at the half power points (3 dB from the maximum amplitude).

An amplitude and a phase curve will give adequate information of well separated resonances, but for curves with resonance peaks strongly overlapping, the information is difficult to interpret.

Plotting the response in a vectorial diagram, a Nyquist diagram has proved to be more convenient. The axes in a Nyquist diagram are the real and imaginary parts of the response. The numerical value of the vector is equal to the amplitude and the angle to the real axis equals the phase angle between the excitation and the response. Thus each point on the periphery corresponds to a certain frequency.

A resonance will be represented by a circle, where the intersection with an axis takes place at the resonance frequency, the axis dependent on the phase-relationship between force and response. The size of the circle depends on the damping, a higher damping giving a smaller circle.

Instead of being plotted against each other the real and imaginary part of the response can also be plotted against frequency.

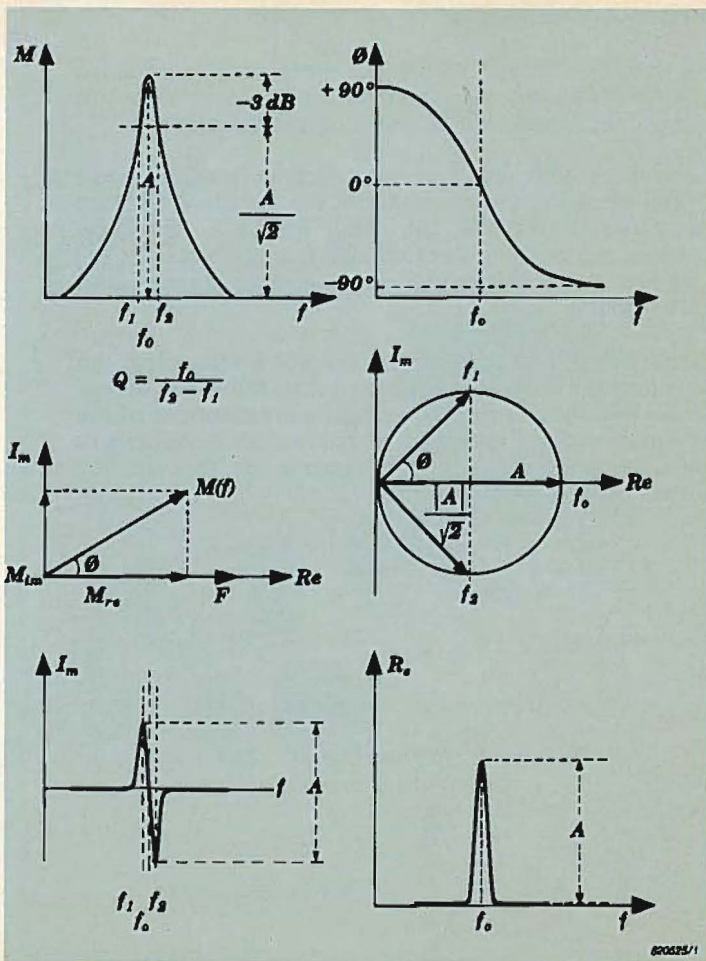

## Use of Complex Plots

From a Nyquist plot the damping can be calculated as the 3 dB points are easily found. However, in practice the curve will not be a circle and will not pass through the zero due to interference of other resonances, but a circle can always be constructed to fit the curve at resonance. This circle will represent the response from a single mode and from this the damping can be calculated.

A frequency sweep will give a circle for each resonance, sometimes making the determination of the resonance frequencies troublesome. Nyquist plots are therefore ideal for the study of a single resonance whereas the plots of the complex parts against frequency are better suited for finding the resonance frequencies. Compared to an amplitude plot, the peaks are narrower and the direction of the peak gives information of the phase between excitation and response. The curves shown on the figure indicate that the part of the structure on which the measurement is made, is vibrating in opposite phases at the two resonance frequencies.

Modern sine exciter controls have provisions for calculation of the complex functions, presenting these as analogue signals. When digital analyzers are used the functions are calculated from the information of amplitude and phase obtained by measuring the spectra of excitation and response.

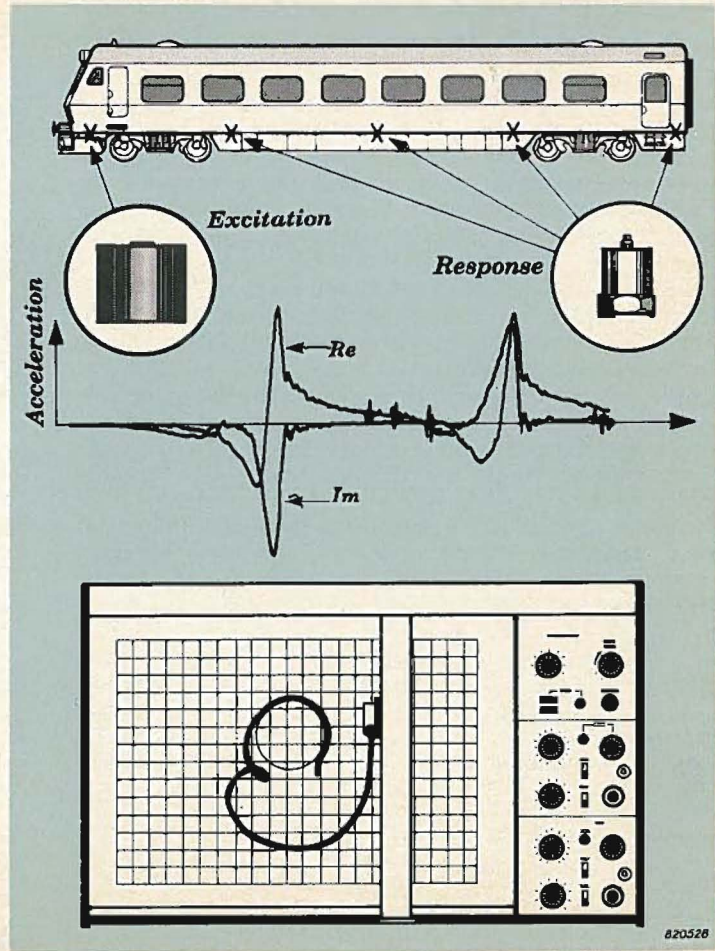



## Excitation Methods

A vibration exciter is an excellent means of providing the force input to the structure to be analyzed either by applying a sine or a broad band signal. In the latter case the input as well as the output are measured and analyzed using Fast Fourier Techniques (FFT). The frequency response is calculated from the input spectrum, measured with a force transducer, and the output spectrum, normally measured with an accelerometer.

Instead of using an exciter a broad band excitation can be produced by an impact hammer integrally mounted with a force transducer. The impact method is fast: the impulse contains energy at all frequencies and will therefore excite all modes simultaneously. The set-up time is minimal and the requirements to the amount of equipment are small. However, the signal to noise ratio is poor and for large, fragile structures with a high degree of damping it can be impossible to get a sufficiently large response without damaging this test object. The vibration exciter has a high signal to noise ratio, an easy control with a choice of excitation waveforms and the possibility of exciting several points at the same time.

Regardless of the excitation method the response is studied as described on the previous pages, and to obtain the mode shape either the excitation or the measurement of the response should be performed at several points on the structure.

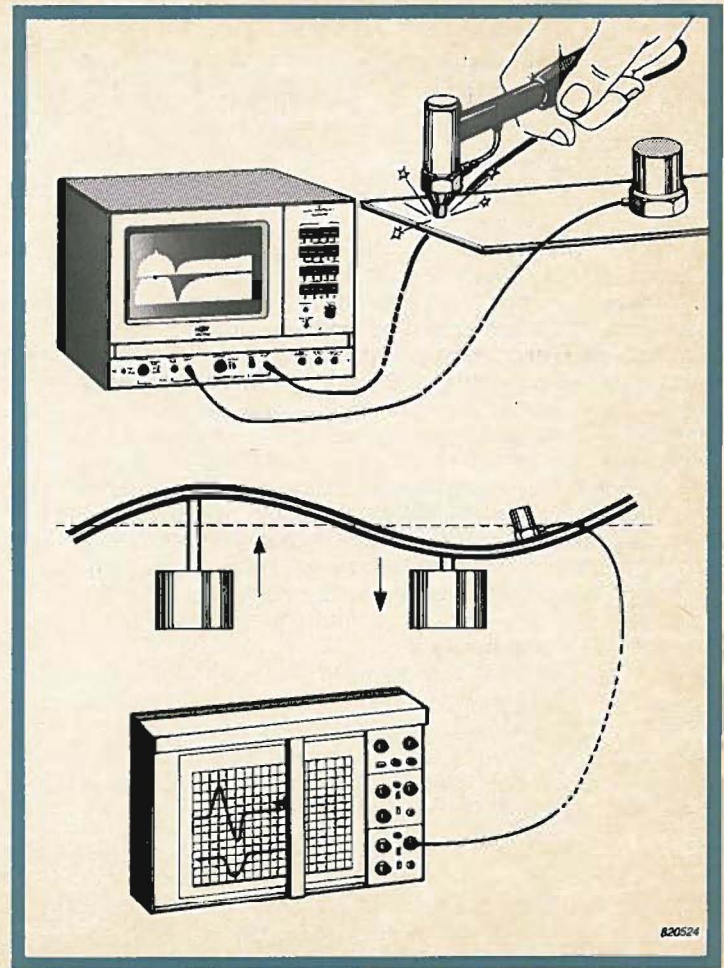

## Multi-Shaker Systems

Use of more than one exciter can be necessary for the simple reason of obtaining a larger force or a distribution of the total force by acting at different points, but more often multi-shaker systems are used to separate vibration modes.

If a uniform structure is vibrating in a pure mode all points of it will vibrate either in phase or in antiphase. In practice this is only seldom the case. The vibration is a result of more than one mode, indicated on the complex plot by circles not symmetrical to the axis. By placing more exciters on the structure their relative forces can be adjusted to eliminate the vibration due to other modes than that to be studied, indicated by symmetry of the complex plot.

Each mode to be eliminated requires an exciter, but a few exciters will normally be sufficient to produce a practically pure mode. Where only a few exciters are needed it is possible to adjust their forces manually to obtain the phase or antiphase response, but for larger systems the setting-up of the exciters as well as the data treatment is computerized.

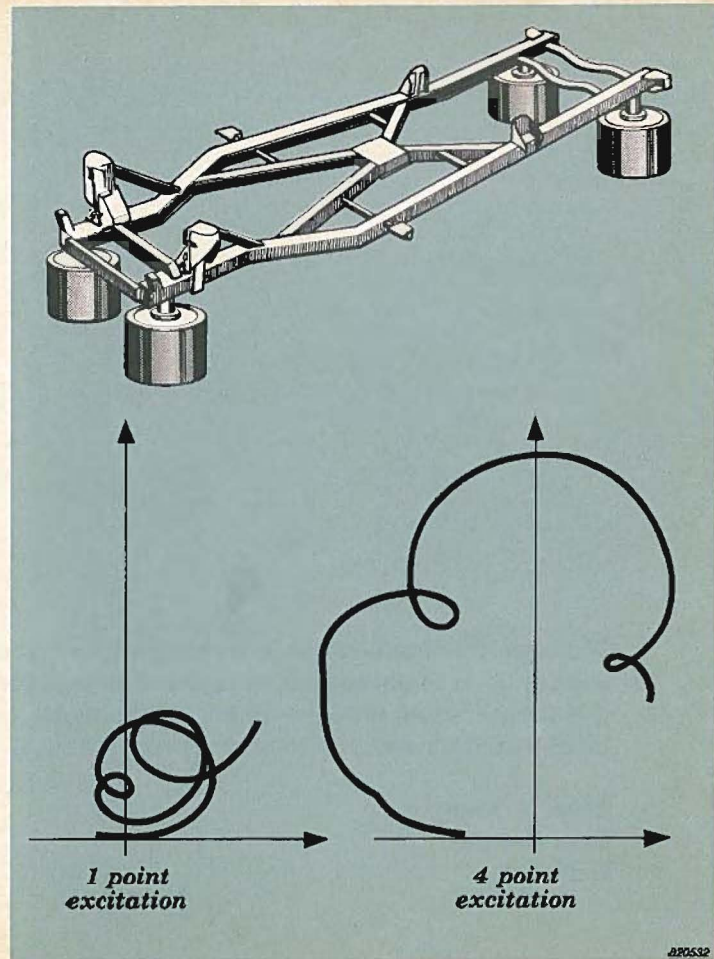



We hope this booklet has answered a lot of questions for you and will continue to serve as a handy reference guide. If you have other questions about measurement techniques or instrumentation, please contact one of our local representatives, or write directly to:

**Brüel & Kjær**  
**2850 Nærum**  
**Denmark**

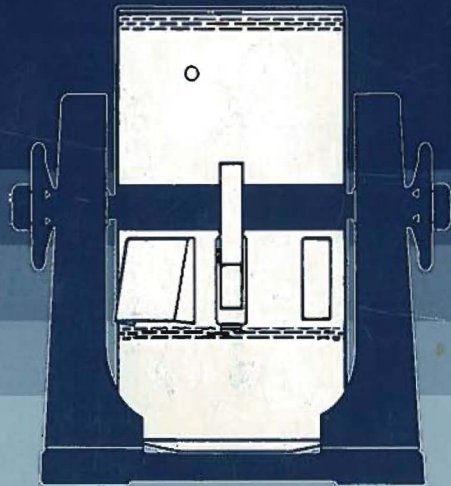

## Brüel & Kjær

DK-2850 NÆRUM, DENMARK

Telephone: + 45 2 80 05 00

TELEX: 37316 bruka dk